

Specifications

Power supply	Single-phase AC 100 – 230 V (- 10 ~ + 8%), 50 / 60 Hz Average wattage : ≈ 690 W / Max wattage : ≈ 990 W Equipment power capacity : 1.2 kVA	
Display	23 in wide LCD display	
Memory storage capacity	Hard disk drive 500 GB (30 GB for initial shipment models)	
External input/output	USB 3.0 x 2-port	
Operation interface	Optical mouse with scroll wheel, Mini keyboard	
Imaging unit	Camera	CMOS 2048 x 1544 pixels
	Optical lens	Bright-field 4x
	Light source	White LED
Recommended use environment	Ambient temp.	Accuracy assured at 23°C±2°C Function assured at 10 - 35°C (Average temp. should be below 30°C for operations lasting over 24hours)
	Relative humidity	45 - 60%RH (no condensation)
	Installation	Ensure there is no dirt, dust or corrosive gas. Avoid placing under strong lighting or direct sunlight. Install on horizontal solid floors.
Sterilizing lamp	UV 15 W, Qty : 2	
Air purifier	HEPA filter Qty : 2	

Optional accessories

Microscope	Optical lens	Bright-field 10x
	Fluorescence imaging	Fluorescence filter 3 blocks (exchangeable) Light source : UV Xenon lamp Lens : 4x, 10x
Glass heater	Between room temp. and 50°C	
Touch panel display	23 in wide LCD monitor	

Dimension

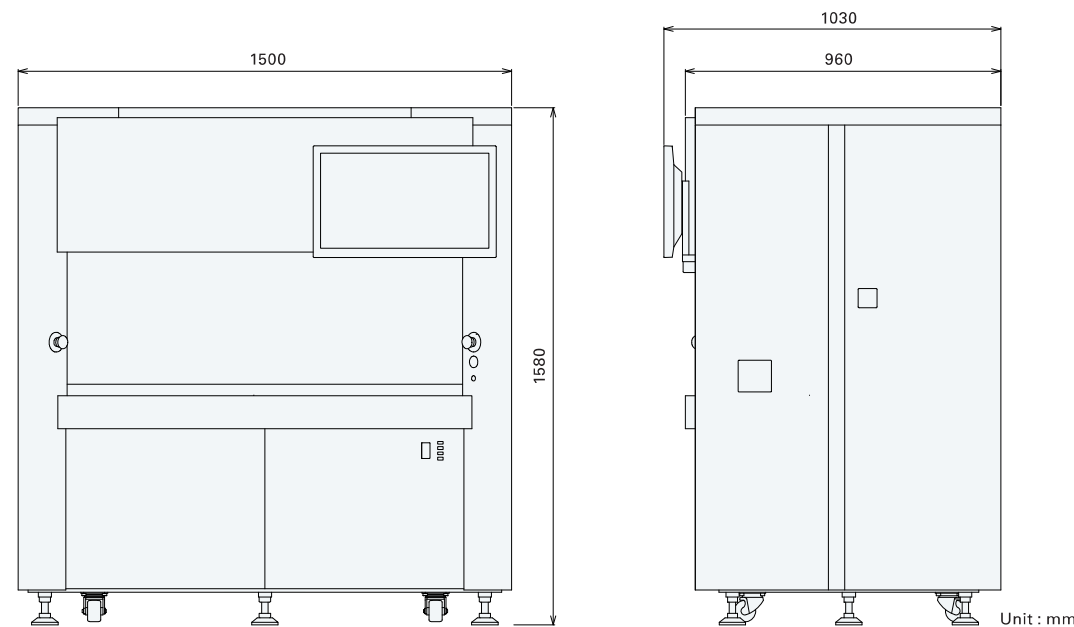

Weight : approximately 600 kg



Cell picking & imaging system CELL HANDLER™



Yamaha Motor Co., Ltd.

<https://global.yamaha-motor.com/business/hc/> yeh@yamaha-motor.co.jp

*For research use only. Not for use in diagnostic or therapeutic procedures.

*The specifications are subject to change without notice.



Cell picking & imaging system

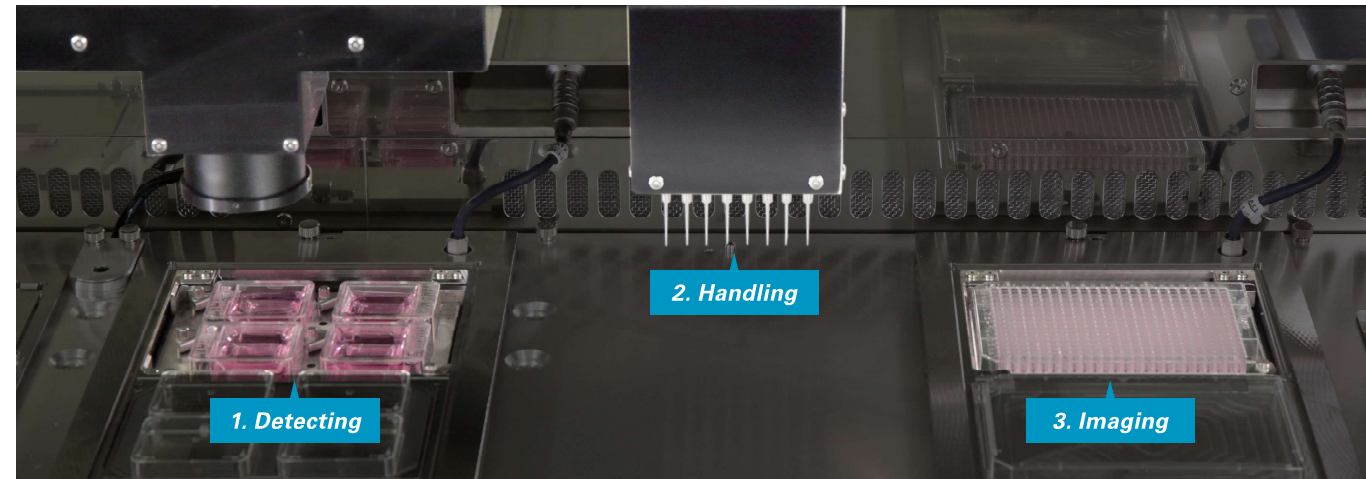

For Cell Selection For Drug screening

CELL HANDLER™ offers new and revolutionary solutions for applications in the biomedical field by utilizing our state of the art ultra high speed pick and place robotic technology.

This technology enables the selection and transfer of a targeted cell to a microplate well, a process that is difficult using conventional manual methods. In addition, the system performs high throughput image analysis.

* The cell mentioned in this brochure is a single cell and/or aggregated cells including spheroids and organoids.

1. Detecting

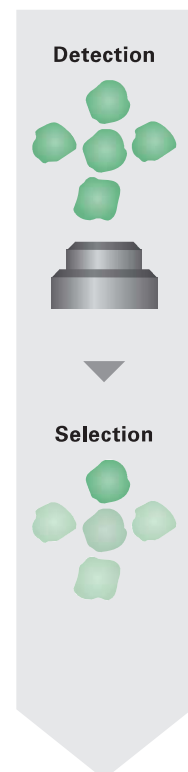

CELL HANDLER™ can report multiple features of an individual cell. These features are summarized statistically and can be used for cell selection.

1) Automated Selection (Histogram)

All features of the cells are visualized in histograms. The cut-off threshold or selection range of a feature can be determined using the histogram. By combining selection criteria of multiple features (maximum of 6 parameters), the desired group of cells can be selected. Threshold values are saved and retrieved for reiterative experiments.

2) Manual Selection (Machine learning)

Cells can be selected manually by checking them one by one and selecting the desired cells. Through this action, the cell preference can be instructed to the CELL HANDLER™ using the machine learning (ML) function. This function calculates the matching level score of each cell. The score is provided as one of the histogram thresholds for the selection of cells.

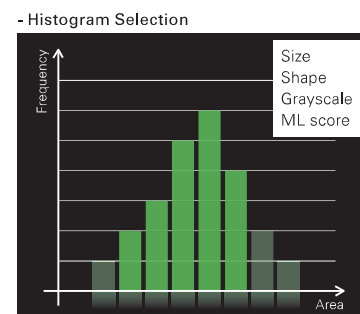
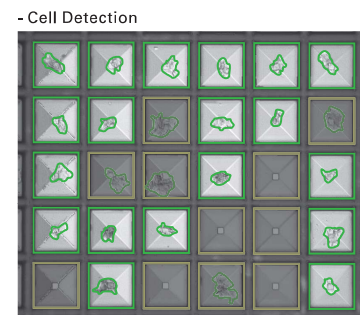

2. Handling

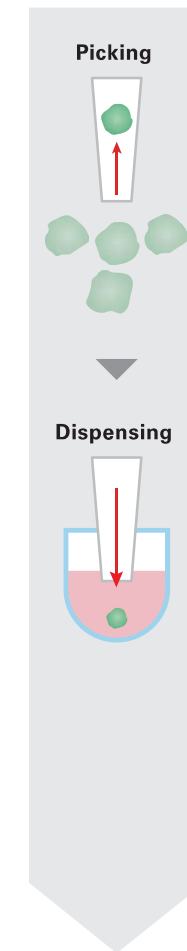

Cells are transferred one by one from a source well to a new well in the destination plate. This process is executed for 8 wells at the same time using 8 individual tips, and therefore is gentle and highly efficient.

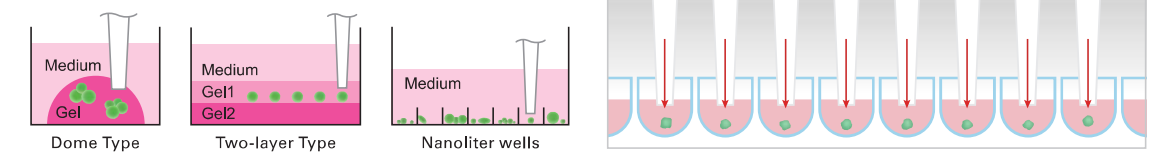

1) Types of Biological Material

- Single cell
- Spheroid / Organoid
- Tissue fragment

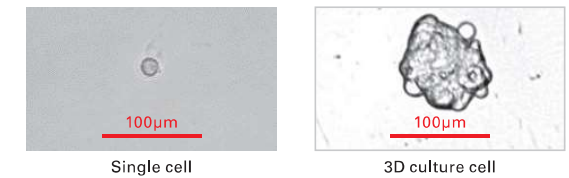

2) Source and destination plates

-Picking from various plates

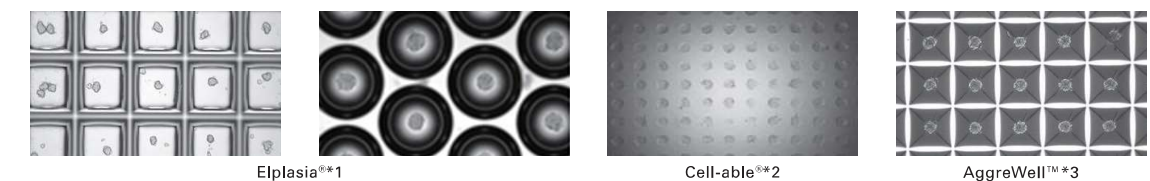
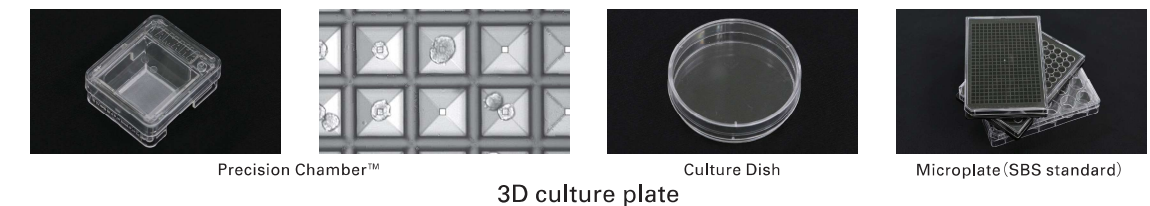

-Dispensing to microplate

*1 "Elplasia" is a registered trademark of Corning Inc..
*2 "Cell-able" is a registered trademark of TOYO GOSEI CO., LTD..
*3 "AggreWell" is a trademark of STEMCELL Technologies Inc..

3. Imaging

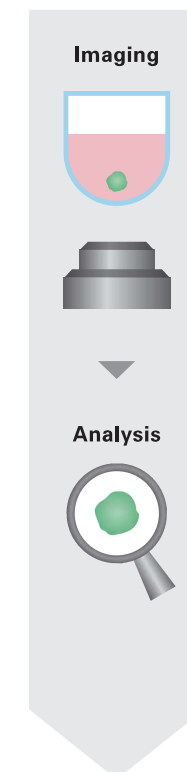

High resolution cell images are captured at high speed.

1) Imaging

CELL HANDLER™ can capture not only bright field but also fluorescent images. A whole well can be observed as stitched image.

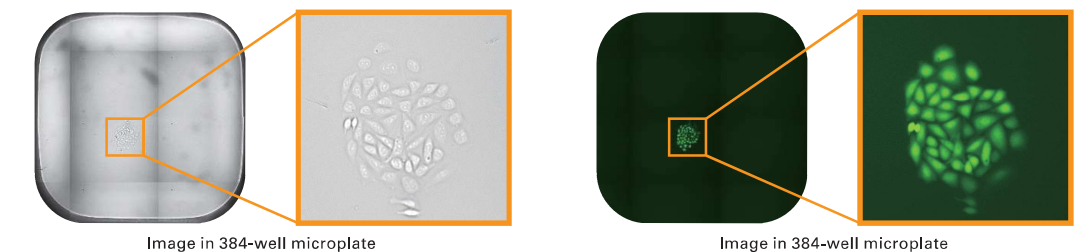

2) Image analysis

Cells are identified using object recognition software and features are reported and saved for analysis.

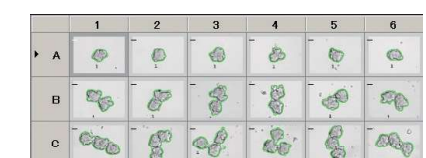
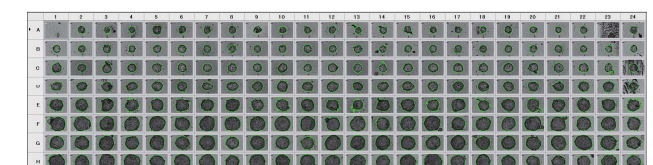

A variety of conditions can be created in one plate.